

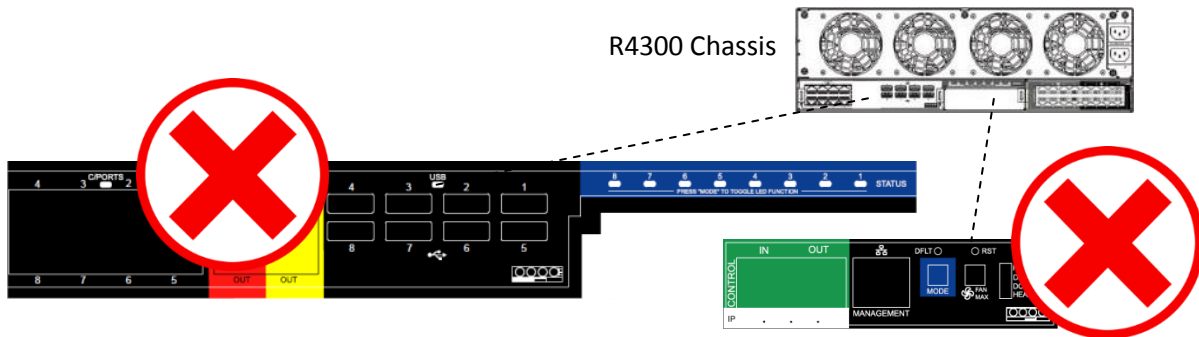

**Do not use incompatible R4300 Chassis Modules with R3092D Blade PCs.**  
 Incompatible chassis modules are shown below:



R4387 8x8 Connect Module (XCM)  
 P/N G091068  
**INCOMPATIBLE with R3092D**

R4345 Remote Management Module (RMM)  
 P/N G091070  
**INCOMPATIBLE with R3092D**

You must use the compatible chassis modules shown below:



R4389 PCoIP/USB Pass-through Module (PUP)  
 P/N G0900388  
**REQUIRED with R3092D**

RMM Filler Module  
 P/N G0900387  
**REQUIRED with R3092D**



Powering on and using R3092D Blade PCs with incompatible R4300 Chassis Modules can damage the blade, the chassis modules, or both.

Be sure to replace any incompatible chassis modules in R4300 Chassis with the compatible chassis modules shown here.

Contact **ClearCube Support** for more information. For contact details, see [Contacting Support](#) below.

# R3092D Blade PC Quick Start Guide

## R3092D Blade PC Overview

### Front panel

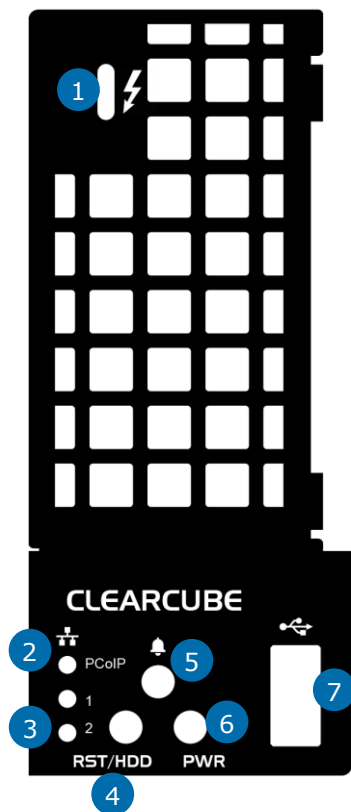

Number	Part	Function
1	Thunderbolt™ port	For Thunderbolt devices (such as displays and peripherals).
2	PCoIP connection indicator	Illuminated to indicate that a PCoIP client is connected to the blade's PCoIP host card.
3	Network activity indicators	<b>1 (Primary LAN)</b> <b>2 (Secondary LAN):</b> Flashes to indicate network activity on the specified port.
4	Reset button and disk activity indicator	<b>Button:</b> Press to reset blade power. <b>Indicator:</b> Flashes to indicate storage drive activity.
5	Standby power	<i>Reserved for future use.</i> This indicator is illuminated when an R3092D is inserted in a chassis, indicating standby power available.
6	Power button and indicator	<b>Button:</b> Press to power on and off blade. Press and hold for three seconds to force power off. Button is illuminated (solid) when power is on. <b>Indicator:</b> Flashes slowly when blade is in standby (Windows Sleep power state).
7	USB 3.0 ports	For USB peripherals and devices.

*Continued on next page*

## R3092D Blade PC Overview, Continued

### Overview of Blade architecture

R3092D Blade PCs are 3U-high, single-slot blades that mount in an R4300 Chassis. Eight R3092D blades can fit in one R4300 Chassis, which provides power, network interfaces, and USB ports for each blade.

In typical ClearCube environments, blades are centrally-located in data centers. Each blade user has a zero client on their desk that is connected over an IP network to an R3092D blade. Zero clients provide the interface to the blade (that is, monitors, keyboard, mouse, and so on).

The picture below shows a high-level example of zero clients connected to R3092D blades in an R4300 chassis.

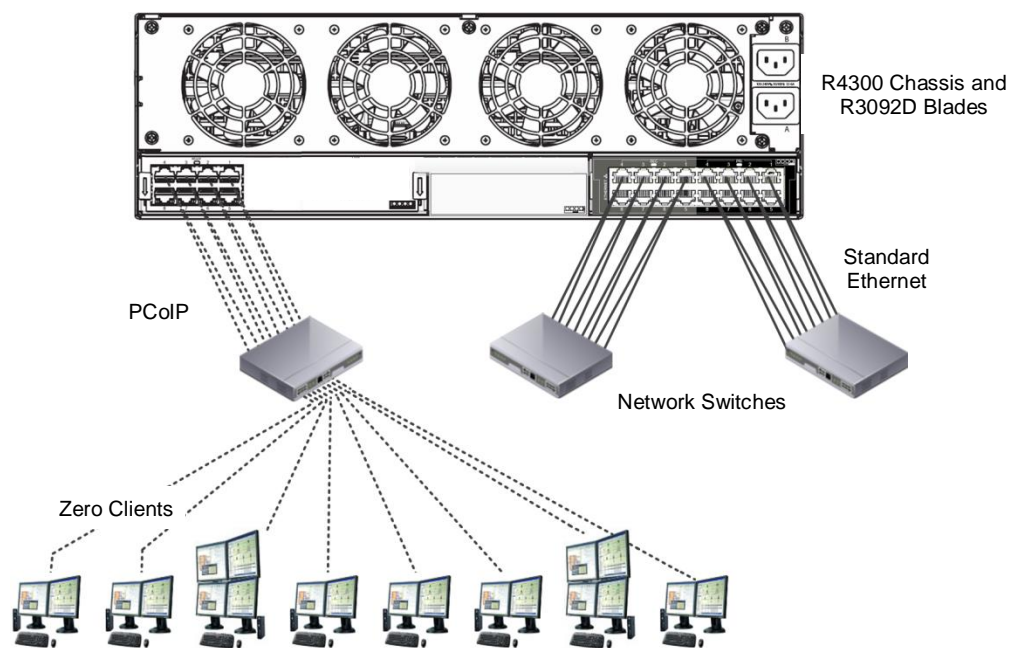

Figure 1. R-Series chassis and R3092D blades connected to zero clients over PCoIP connections

## R3092D and the Blade Chassis

### Inserting a blade in a chassis

The R4300 chassis (shown in [Figure 1](#) above) provides blade power, network ports (Ethernet and dedicated PCoIP), and USB ports for all blades in a chassis.

The steps below show how to install and remove an R3092D blade from an R4300 chassis.

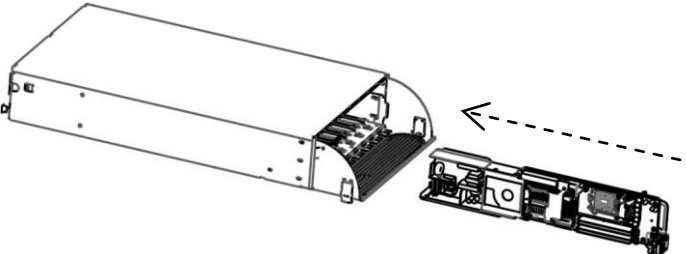

Step	Action
1	<p><b>CAUTION:</b> Before inserting any R3092D Blade PC into a chassis, be sure to read warnings on the first page of this guide.</p> <p>Lower the front bezel on the chassis by depressing the latches on each side of the bezel.</p>
2	<p>Orient each blade right-side up (so the front panel buttons are on the bottom). Slowly insert the blade into the chassis by lining up the blade edges with the top and the bottom slot guides.</p>
3	<p>Start inserting blades from the left-most slot (slot #1). There is a slight resistance when the back connector goes into the backplane socket (blade might look different than blade in picture below).</p>  <p><b>Figure 2. Inserting a blade in an R4300 chassis (blade may look different)</b></p> <p>When properly seated, the Blade PC is flush with the front edge of the bottom guide bracket.</p> <div style="border: 1px solid black; padding: 5px; background-color: #f0f0f0;"> <p><b>CAUTION:</b> Never force blades into a chassis. Mishandling blades can cause critical hardware failure, data loss, or both.</p> </div>
4	<p>After inserting all blades, raise the chassis <b>front bezel</b> and snap into place.</p>

*Continued on next page*

## R3092D and the Blade Chassis, Continued

### Removing a blade from a chassis

The steps below show how to remove an R3092D from a chassis.

Step	Action
1	<p>Open the chassis door and press the <b>power button</b>, located on the right-hand side of the front panel. (See item 6 in “<a href="#">Front panel</a>” above for the location of the power button.) Wait for the power light to turn off.</p> <div style="border: 1px solid black; padding: 5px; background-color: #f0f0f0;"> <p><b>CAUTION:</b> Always completely power down a blade using the power button or by shutting down the OS before removing it from a chassis. Removing a blade before completely powering down can cause critical hardware failure, data loss, or both.</p> </div>
2	<p>Hold the blade by the <b>handle</b> and pull back to remove the blade. Support the rear of the blade as you remove it from the chassis.</p> <div style="border: 1px solid black; padding: 5px; background-color: #f0f0f0;"> <p><b>CAUTION:</b> Never forcefully remove blades from a chassis. Mishandling blades can cause critical hardware failure, data loss, or both.</p> </div> <div style="border: 1px solid black; padding: 5px; background-color: #f0f0f0; margin-top: 10px;"> <p><b>CAUTION:</b> Use care when handling blades; some surface might be hot.</p> </div>

### Standard network cabling

The *Network Module* (or *EP2*) on the rear of an R4300 Chassis provides two Gigabit Ethernet ports (one Primary port and one Secondary port) for each blade. Primary and Secondary ports support Ethernet for standard network traffic. Note that the PUP Module on the left side of the chassis provides dedicated ports for PCoIP network(s).

- **Primary ports (Pri)**—located on the right-most side of the Network Module.
- **Secondary ports (Sec)**—located on the left-most side of the Network Module.

The picture below shows the Network Module on the rear of the R4300 Chassis.

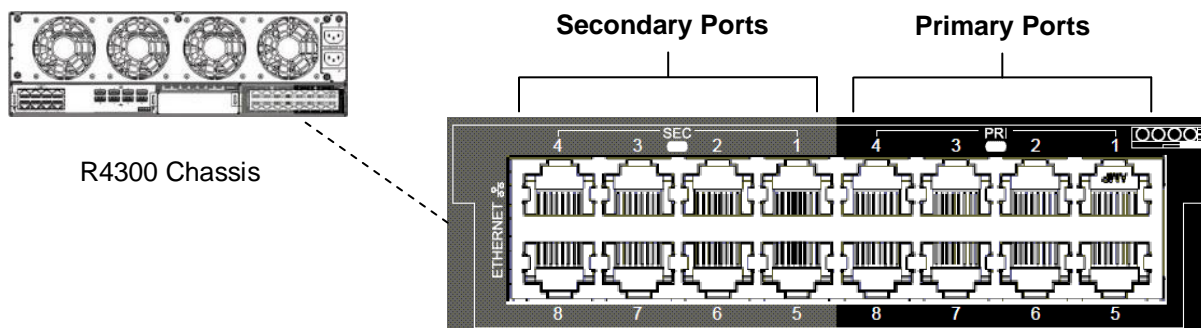

Figure 3. Network Module’s Primary and Secondary ports for standard Ethernet connections

Continued on next page

## R3092D and the Blade Chassis, Continued

### PCoIP network cabling

The *PCoIP/USB Pass-through Module* (or *PUP*) on the rear of an R4300 Chassis provides Gigabit Ethernet ports dedicated to PCoIP traffic and USB ports for each blade. Note that PCoIP port numbers and USB port numbers corresponds to R4300 Chassis slot numbers. For example, PCoIP and USB port three belong to the blade in chassis slot three.

The picture below shows the PUP Module on the rear of the R4300 chassis.

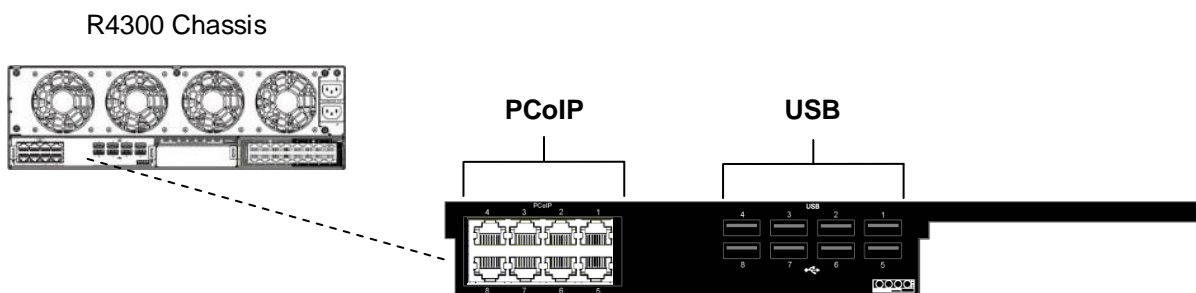

Figure 4. The PCoIP and USB ports on the PCoIP/USB Pass-through Module

## BIOS and Pre-OS Video

### About pre-OS video

You can view pre-OS video:

- **Remotely:** Establish a PCoIP session from a remote zero client.
- **Locally:** Connect a keyboard and monitor directly to the blade.

### Enabling Accelerated Monitor Emulation

In the R3092D architecture with PCoIP host cards, USB is redirected to zero clients after the operating system starts.

Before you can access pre-OS video (such as BIOS setup utility screens), you must enable Accelerated Monitor Emulation on the PCoIP host card (note that monitor emulation is enabled by default). After enabling monitor emulation, you can use a zero client and a locally-connected keyboard to view pre-OS video and change BIOS settings. Note that you only need to enable monitor emulation one time.

*Continued on next page*

## BIOS and Pre-OS Video, Continued

### Before you begin

Before you begin, be sure to have

- A computer with a Web browser on the same network as the blade you are configuring
- Ethernet cables
- a zero client power supply
- a ClearCube zero client compatible with the blade's video configuration. The blade's video configuration is specified on a label on the side of the blade.
- a monitor and power cable
- a USB keyboard and a mouse, and
- a switch connected to a DHCP network.

**NOTE:** These instructions assume devices are connected to an imaging network or other network with a DHCP server to provide IP addresses for the blade's PCoIP host card and for the zero client. PCoIP device MAC addresses are specified on labels on the side of the blade and on the zero client. To identify the host card to connect to from the zero client, you might need to consult DHCP tables. DHCP tables should show each device's MAC address and the corresponding IP address assigned to the host card and the client.

### Remote: connecting devices

The table below shows how to connect devices to view pre-OS video remotely (see *R4300 Chassis Quick Start Guide*, available on the Support site, for more information about the R-Series chassis).

Step	Action
1	Insert the blade in the chassis as described in " <a href="#">Inserting a blade in a chassis</a> " above.

*Continued on next page*

## BIOS and Pre-OS Video, Continued

Remote:  
connecting  
devices  
(continued)

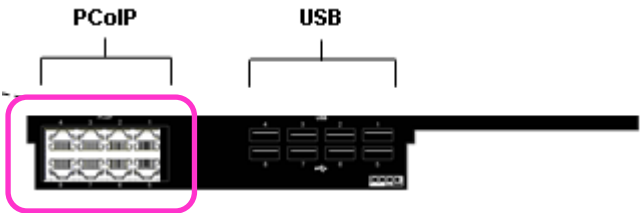
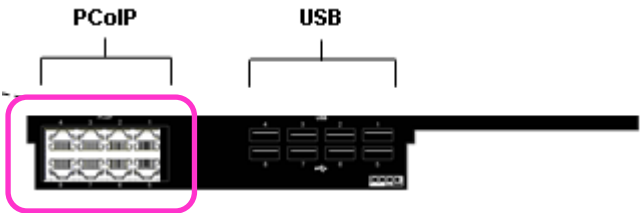
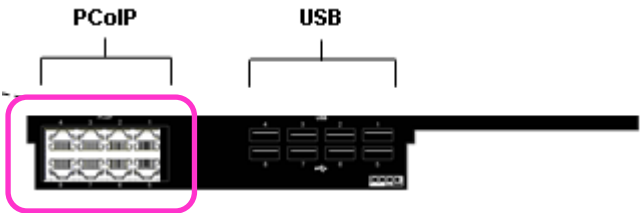
Step	Action										
2	<p>Connect the blade and the zero client to your network.</p> <table border="1"> <thead> <tr> <th>Step</th> <th>Action</th> </tr> </thead> <tbody> <tr> <td>1</td> <td>Note the chassis slot in which the R3092D Blade PC is located (slots are numbered 1 to 8, where 1 is the left-most slot when viewing the front of the chassis).</td> </tr> <tr> <td>2</td> <td> <p>Insert an Ethernet cable in the appropriate <b>PCoIP</b> port on rear of the chassis. From the <i>PUP Module</i> (shown below), find the PCoIP port that corresponds to the slot in which the blade is located. Connect one end of an Ethernet cable to this port, and connect the other end to a network switch on the same network as the zero client (this can be the same switch).</p>  <p><b>Figure 5. PUP Module's PCoIP ports support PCoIP connections</b></p> </td> </tr> <tr> <td>3</td> <td>Use another Ethernet cable to connect the zero client to the same network switch.</td> </tr> <tr> <td>4</td> <td>If you are imaging the blade, connect an Ethernet cable to a Network Module Ethernet port on the rear of the chassis and connect the other end of the cable to the network switch. The Network Module's <b>Pri</b> ports (Primary Ports) and <b>Sec</b> (Secondary Ports) support standard Ethernet connections.</td> </tr> </tbody> </table>	Step	Action	1	Note the chassis slot in which the R3092D Blade PC is located (slots are numbered 1 to 8, where 1 is the left-most slot when viewing the front of the chassis).	2	<p>Insert an Ethernet cable in the appropriate <b>PCoIP</b> port on rear of the chassis. From the <i>PUP Module</i> (shown below), find the PCoIP port that corresponds to the slot in which the blade is located. Connect one end of an Ethernet cable to this port, and connect the other end to a network switch on the same network as the zero client (this can be the same switch).</p>  <p><b>Figure 5. PUP Module's PCoIP ports support PCoIP connections</b></p>	3	Use another Ethernet cable to connect the zero client to the same network switch.	4	If you are imaging the blade, connect an Ethernet cable to a Network Module Ethernet port on the rear of the chassis and connect the other end of the cable to the network switch. The Network Module's <b>Pri</b> ports (Primary Ports) and <b>Sec</b> (Secondary Ports) support standard Ethernet connections.
Step	Action										
1	Note the chassis slot in which the R3092D Blade PC is located (slots are numbered 1 to 8, where 1 is the left-most slot when viewing the front of the chassis).										
2	<p>Insert an Ethernet cable in the appropriate <b>PCoIP</b> port on rear of the chassis. From the <i>PUP Module</i> (shown below), find the PCoIP port that corresponds to the slot in which the blade is located. Connect one end of an Ethernet cable to this port, and connect the other end to a network switch on the same network as the zero client (this can be the same switch).</p>  <p><b>Figure 5. PUP Module's PCoIP ports support PCoIP connections</b></p>										
3	Use another Ethernet cable to connect the zero client to the same network switch.										
4	If you are imaging the blade, connect an Ethernet cable to a Network Module Ethernet port on the rear of the chassis and connect the other end of the cable to the network switch. The Network Module's <b>Pri</b> ports (Primary Ports) and <b>Sec</b> (Secondary Ports) support standard Ethernet connections.										
3	Connect a monitor and a mouse to the <b>zero client</b> .										
4	Connect the zero client <b>power adapter</b> to the client and then plug the cord into a power outlet.										

**Next steps:** Ensure Accelerated Monitor Emulation is enabled on the blade's PCoIP host card.

*Continued on next page*



## BIOS and Pre-OS Video, Continued

**Remote: create session and view video**

When connecting to an R3092D blade to view pre-OS video, you can:

- Establish a PCoIP session within 45 seconds of powering on the blade and pressing **F2** to view BIOS setup utility or pressing **F10** to view the boot menu.

—OR—

- Establish a PCoIP session and log in to the operating system, then restart the blade.

The table below shows how to create a PCoIP session to view pre-OS video before the operating system requests login credentials.

Step	Action
1	Press the <b>power button</b> on the front of the blade to power it on, and then press the <b>power button</b> on the front of the zero client to power it on.
2	From a monitor connected to the zero client, click the <b>Connect</b> button.  <b>Result:</b> After several moments the zero client identifies host cards to which it can connect. The zero client on-screen display (OSD) lists one or more host card IP addresses and their corresponding MAC addresses.  <b>NOTE:</b> The PCoIP host card MAC address is specified on a label on the side of the blade.
3	Select the blade's <b>host card</b> from the list and click <b>OK</b> .  <b>Result:</b> The zero client and blade establish a PCoIP session and the blade displays pre-OS video.
4	Repeatedly press the keyboard's <b>F2</b> key for approximately 15 seconds to enter the BIOS Setup utility, or press <b>F10</b> to display the boot menu. If the operating system starts before you access pre-OS screens, restart the blade to view the pre-OS video and prompts. Press the appropriate key when prompted.
5	After performing configuration steps, press <b>F10</b> to save changes and reset the blade.

**Next step:** you can now deploy the blade.

*Continued on next page*

## BIOS and Pre-OS Video, Continued

### Local: view pre-OS video

Obtain a Thunderbolt (USB-C)-to-DisplayPort cable before performing these steps. The table below shows how to view pre-OS video locally.

Step	Action
1	Connect a monitor to the blade you are accessing. Plug the Thunderbolt 3 connector into the port on the front of the blade.
2	Connect a USB keyboard to a port on the front of the blade.
3	Press the blade's power button to power it on. Repeatedly press the <b>F2</b> key to view the BIOS setup utility, or press the <b>F10</b> key to view the boot menu.

## Related Information and Support

### Related information

The table below shows documents about R3092D configuration, operation, and maintenance.

For information about ...	See ...
Creating custom operating system images	<i>Tech Bulletin TB00265, Operating System Image Requirements</i>
Blade and chassis setup, operation, upgrades, and maintenance	<i>R-Series Data Center Products User's Guide</i>
PCoIP device configuration and administration	<i>PCoIP System User's Guide</i>

All documentation is located at <http://www.clearcube.com/support/>

### Contacting Support

<b>Web</b>	<a href="http://www.clearcube.com/support/">www.clearcube.com/support/</a>
<b>Email</b>	<a href="mailto:support@clearcube.com">support@clearcube.com</a>
<b>Toll-free</b>	(866) 652-3400
<b>Direct</b>	(512) 652-3400

#### WEEE Disposal Guidelines

In the European Union, this electronic product falls under the European Directive (2002/96/EC) WEEE. When it reaches the end of its useful life or is no longer wanted, it should not be discarded with conventional waste, but disposed of at an approved designated recycling and/or treatment facility. Laws are different in each country, so please check with your local authorities for proper disposal instructions. For assistance, contact ClearCube at [recycle@clearcube.com](mailto:recycle@clearcube.com).

